



User's Manual

Network Set-up and Operation

Wired Setting

Projector Set-up and Operation

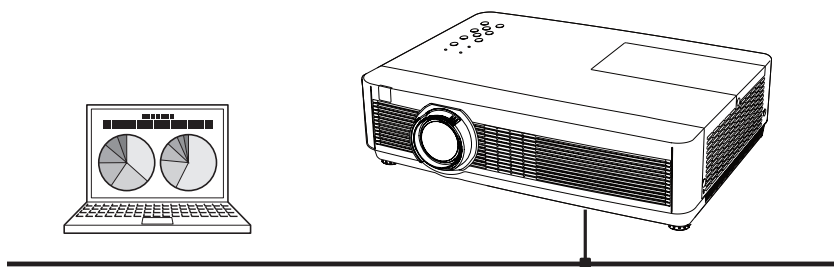

This is the manual for the Network function.
Read this manual thoroughly to operate the Network function.
First, read the user's manual of the projector to understand the basic operation of the projector and the safety instructions.
The safety instructions in the user's manuals should be followed strictly.

for LV-8320

Compliance

Federal Communications Commission Notice

Model: LV-8320

This device complies with Part 15 of the FCC Rules. Operation is subject to the following two conditions:

- (1) This device may not cause harmful interference, and
- (2) this device must accept any interference received, including interference that may cause undesired operation.

Note: This equipment has been tested and found to comply with the limits for a Class B digital device, pursuant to Part 15 of the FCC Rules. These limits are designed to provide reasonable protection against harmful interference in a residential installation. This equipment generates, uses and can radiate radio frequency energy and, if not installed and used in accordance with the instructions, may cause harmful interference to radio communications. However, there is no guarantee that interference will not occur in a particular installation. If this equipment does cause harmful interference to radio or television reception, which can be determined by turning the equipment off and on, the user is encouraged to try to correct the interference by one or more of the following measures:

- Reorient or relocate the receiving antenna.
- Increase the separation between the equipment and receiver.
- Connect the equipment into an outlet on a circuit different from that to which the receiver is connected.
- Consult the dealer or an experienced radio/TV technician for help.

Use of shielded cable is required to comply with class B limits in Subpart B of Part of FCC Rules.

Do not make any changes or modifications to the equipment unless otherwise specified in the instructions. If such changes or modifications should be made, you could be required to stop operation of the equipment.

Canon U.S.A., Inc.

One Canon Plaza, Lake Success, NY 11042-1198, U.S.A.

Tel No. (516)328-5600

Canadian Radio Interference Regulations

This class B digital apparatus complies with Canadian ICES-003.



CAUTION IN USING THE PROJECTOR VIA NETWORKS

- When you find a problem with the projector, remove the power cable immediately and inspect the unit. Using the projector with failure may cause fire or other accidents.
- If you remotely use the projector via networks, carry out a safety check regularly and take particular care to its environment. Incorrect installation may cause fire or other accidents.

CAUTION IN USING NETWORK FUNCTION







- We assume no responsibility for the loss or damage of data, or damage of the computer caused by using this projector. Making back-up copies of valuable data in your computer is recommended.

Safety instructions

Please read and understand all instructions thoroughly before using.

About safety symbols







The following symbols are used in this manual to alert you to important safety information. Always observe the instructions to reduce the risk of injury and property damage.

 WARNING	Indicates a potentially hazardous situation which, if not avoided, may cause death or serious injury.
 CAUTION	Indicates a potentially hazardous situation which, if not avoided, may cause minor or moderate injury.
	Indicates a potentially hazardous situation which, if not avoided, may cause electric shock.
 	Indicate actions that you are not allowed to perform. The figure shown in the circle with a diagonal line through it denotes the specific prohibited action.
	Indicates other prohibited actions.
	Indicates an action that you must perform. The figure shown in the filled black circle denotes the specific prohibited action.

Safety information

WARNING

Always mount and operate the product in accordance with the safety instructions specified by the projector and peripheral equipment makers.

-   ● Do not attempt to disassemble or service the product yourself. Doing so may result in a fire, an electric shock, or product damage.
-   ● If the projector emits a strange odor, or makes a strange noise, immediately turn the power and peripheral equipment off, unplug these devices, and contact your dealer.
-   ● Do not drop the projector or subject it to strong shocks. Doing so may result in damage to the internal parts, an electric shock, a fire, or product damage.

CAUTION



-  ● The disk which comes with the product is a CD-ROM. As CD-ROM cannot be played back on an audio CD player, never play back on it. Playing back the disc will generate loud noise, resulting in damage to your hearing or the speakers.
-   ● Do not touch the projector with wet hands when the power cord plugs of the projector or peripheral equipment inserted into the electrical outlet. Otherwise, an electric shock may result.

Table of contents

Compliance.....	2
Safety instructions.....	3
Table of contents.....	4
Chapter 1 Preparation	5
Features.....	6
Required operating environment for computers.....	7
Network specifications of the projector.....	7
Flow of installation.....	9
Chapter 2 Setup Procedures.....	11
Connecting to the LAN line.....	12
Network configuration.....	12
Network PIN code.....	14
Network information.....	14
Network factory default.....	15
Wired LAN factory default settings.....	16
Chapter 3 Basic Setting and Operation.....	17
Login the setting page of the projector.....	18
[1] Enter the IP address.....	18
[2] Login.....	18
[3] Display of main setting page.....	19
How to use the setting page.....	20
Initial setting.....	22
Network PIN code setting.....	23
PJLink and password setting.....	23
Network configuration.....	24
E-mail setting.....	25
Examples: Type and contents of alert mail.....	28
SNMP setting.....	29
Chapter 4 Controlling the Projector.....	31
Power control and status check.....	32
Control.....	34
Input.....	34
System.....	35
Sound.....	36
Image adjustment.....	37
PC adjustment.....	38
Setting up the projector.....	39
Aspect setting.....	39
Setting 1.....	40
Setting 2.....	40
Setting 3.....	41
Information.....	42
Chapter 5 Appendix	45
Examples of connection.....	46
Use of telnet.....	48
Web browser setting.....	50
Examples: OS/Browsers.....	51
Q&A.....	55
Menu Tree.....	60

Chapter 1

Preparation

Describes features and operating environment of this projector.

1

Features

Web Management function (p.31)

With this function, you can monitor projector functions such as power status, lamp status, input mode, signal condition, lamp-use time, etc. through the network by using the web browser installed on your computer.

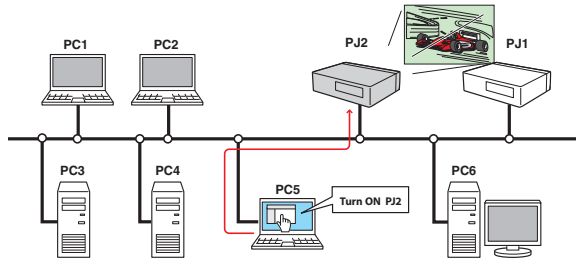

E-Mail Alert function (p.25)

The projector sends messages to the registered e-mail addresses when a lamp abnormality or power failure occurs with the projector. This message describes how to solve the cause of the problems. You can take efficient action for quick recovery.

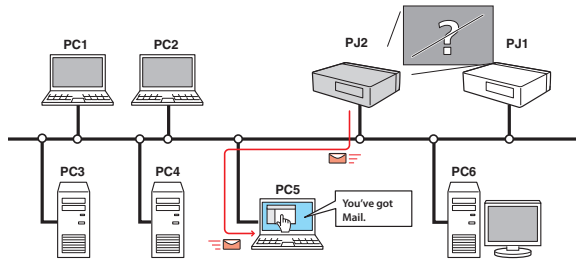

Required operating environment for computers

When operating the projector via networks, computers should meet the operating environment below.

Operating System		Windows XP (32bit version), Windows Vista (32bit version), Windows 7 (32bit version) Mac OS X v 10.4 or 10.5
Computer environment	Recommended CPU	Windows: Pentium III 900MHz or more Macintosh : 800 MHz PowerPC G4 or faster, or 1.8 GHz Intel Core Processor or faster
	Memory	Windows : 64MB (Minimum)/ 128MB or more (Recommended) 128MB or more for Windows XP 1GB or more for Windows Vista or Windows 7 Macintosh : 256MB or more (512MB is recommended)
	Free disk space	100MB or more
	Drive equipment	CD-ROM drive
	Display settings	Support one of following resolutions; VGA (640 x 480), SVGA(800 x 600), XGA(1,024 x 768) Number of colors: Either of 16 bit (65,536 color 24/32 bit (16.77 million colors))
	Network card	The computer must provide a 10Base-T or 100Base-TX network card.
Web Browser*		Internet Explorer version 6.0, 7.0 or 8.0 Netscape Navigator version 7.1 or 9.0 Safari 3.1 * Used to control and set up the projector. The layout of pages in the browser may slightly differ from each type of application or operating system you use.
Recommended Internet Mailer*		- Microsoft Outlook - Microsoft Outlook Express - Netscape Mail * Required the internet e-mail application software to receive an e-mail alert sent from this projector. If you do not use the function E-mail Alert, this application is not required.

Network specifications of the projector

LAN Terminal

Data communication standards	10/100/1000Base-T compatible
Physical layer	10Base-T
Protocol	TCP/IP

Cabling Between the Projector and a Hub or computer*1

Use an appropriate cable when connecting the projector and a hub or computer.

Connection	Ethernet cable type	Max. cable length
Projector - Hub	STP straight-through category 5 *2 cable	100m (328feet)
Projector - Computer	STP crossover category 5*2 cable	100m (328feet)

*1 There may be other limitations depending on your network environment or LAN specification. Please consult your network administrator for further details.

*2 Cable category indicates cable quality.

Notice

Expression/Abbreviation

The OS of the computer and the Web browser described in this manual are Windows XP Professional and Internet Explorer 6.0. In case of another OS or Web browser, some instruction procedures may differ from the actual operation depending on your computer environment.

Use of this manual

This manual does not provide the detailed description of basic operation and functions for computer, web browser, projector and network. For instructions about each piece of equipment or application software, please refer to the respective manual.

Trademarks

Ethernet is a registered trademark of Xerox Corporation. Microsoft, Windows, Windows XP, Windows Vista and Windows 7 are registered trademarks of Microsoft Corporation in the United States and other countries. Internet Explorer is a registered trademark of Microsoft Corporation. Netscape Navigator and Netscape Communicator are trademarks or registered trademarks of Netscape Communications Corporation. JavaScript is a registered trademark of Sun Microsystems, Inc.

Macintosh is a registered trademark of Apple, Inc. in the USA and other countries. PowerPC is a registered trademark of IBM Corporation. Intel Core is a registered trademark of Intel Corporation in the USA and other countries.

Other product or brand names in this manual are registered trademarks or trademarks of their respective owners.

* Unauthorized use of a part or whole of the contents in this manual is prohibited.

* The contents of this manual are subject to change without notice.

Flow of installation

To use the projector via the networks, follow the setup procedures below.

STEP 1

Connect the LAN and set the configuration.



Decide depending on the LAN environment.

→ "2. Setup Procedures" (pp.11–16).

Detailed LAN configurations need to be done with a browser later.

First, complete the Wired LAN connection between computers and projectors, then start browser configurations.

→ "3. Basic setting and operation" (pp.17–30).

STEP 2

Network Configuration has completed.

Follow each chapter to operate the projector.

■ Operate and manage the projector → "4. Controlling the projector" (pp.31-43)

→ "Power Control and status check" (p.32)

→ "Control" (p.34)

→ "PC adjustment" (p.38)

→ "Setting up the projector" (p.39)

→ "Projector information" (p.42)

Chapter 2

Setup Procedures

Describes how to configure the network.

2

Setting procedures and contents differ depending on the LAN installation location. When installing, consult your system administrator to set up the LAN appropriately.

Connecting to the LAN line

Connect the LAN cable to the LAN connection terminal of the projector.

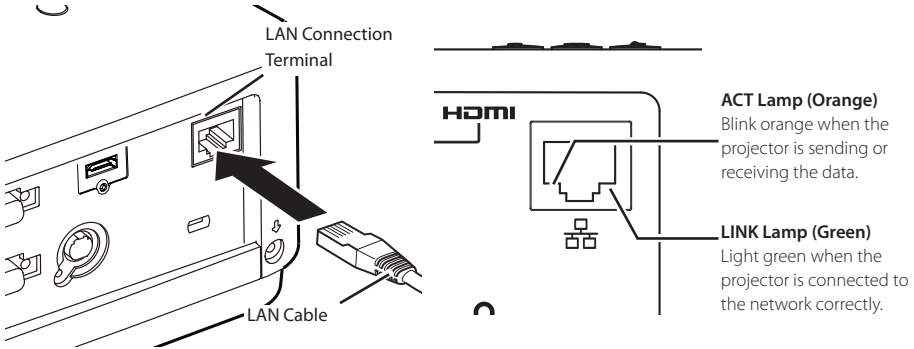

* Please use a shielded LAN cable.

Network configuration

Set the Wired LAN network through the projector menu. Detailed network settings will be made with browser. Refer to "3. Basic setting and operation" (p.17-30). First, complete the settings described in this chapter before performing steps in "3. Basic setting and operation."

Setting Procedure

1. Select "LAN mode select" in the Network menu, and press Point ► or **OK** button.
2. Select similar LAN environment among LAN1, LAN2 and LAN3 with the Point ▲▼ buttons, and press **OK** button. Then the Menu will disappear, the "Please wait..." message will appear, and switching operation will start. Switching will take a while and the projector's LINK/ACT Lamp will be on or blink, and after completing the operation, the "Please wait..." message will disappear.



3. Select "Network setting" in the Network menu and press **OK** button, and then the LAN setting screen will appear and selected LAN settings will be displayed. Adjust each item to the setting environment. Consult your system administrator about the detailed settings.

Press **OK** button in a row where you want to adjust, and adjust the figures with the Point ▲▼ buttons and move among the items with the Point ◀▶ buttons, and then press **OK** button to fix. Move to the next row with the Point ▲▼ buttons to adjust.

4. After completing all the settings, select "Set" and press **OK** button. Now, all procedures have been done. To cancel the adjusted settings, select "Cancel" and press **OK** button.

You can confirm the LAN settings you have made from "Network information" (p.14). In such cases that the LAN cannot be connected, see this screen.

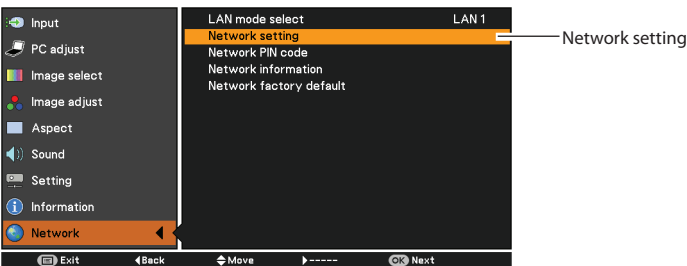

DHCP: On

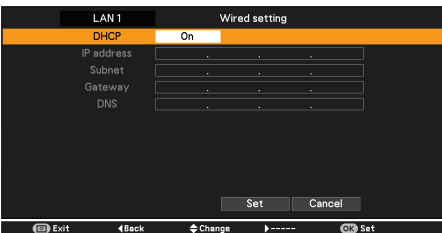

DHCP: Off

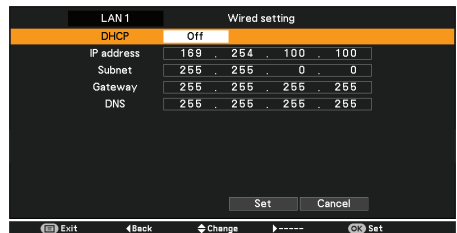

* The numerical value is a setting example.

Item	Description
------	-------------

DHCPSets DHCP function On or Off. When you setup the network setting manually, select "Off". When it is set On, IP address, Subnet, Gateway and DNS are automatically set according to your network environment *1.
------	--

IP addressSets IP address of the projector.
------------	--

SubnetSets Subnet mask according to your network environment.
--------	--

Gateway*2Sets IP address of the default gateway (Router).
-----------	---

DNS*3Sets IP address of the DNS server.
-------	---

*1 Set "On" only when the DHCP server is available on your network environment.

*2 Set [255.255.255.255] if the network does not provide the gateway (router).

*3 Set [255.255.255.255] if you do not use the function E-mail alert.

Network PIN code

The Network PIN code is to restrict the access to the projector through the network. After setting the Network PIN code, you need to enter it to operate the projector via the networks.

1. Select "Network PIN code" in the Network menu, and press **OK** button.
The Network PIN code screen will appear.
2. Set the Network PIN code.

Set the figures with the Point ▲▼ buttons and move to the next items with the Point ◀▶ buttons. Select "Set" and press **OK** button to set. To cancel the preset Network PIN code, select "Cancel". When you do not want to set the Network PIN code, set "0000".

It is recommended to set the Network PIN code if you use the projector via the networks. The Network PIN code can be set also through the networks. See "3. Basic setting and operation" → "Initial setting" → "Network PIN code setting" (p.23).

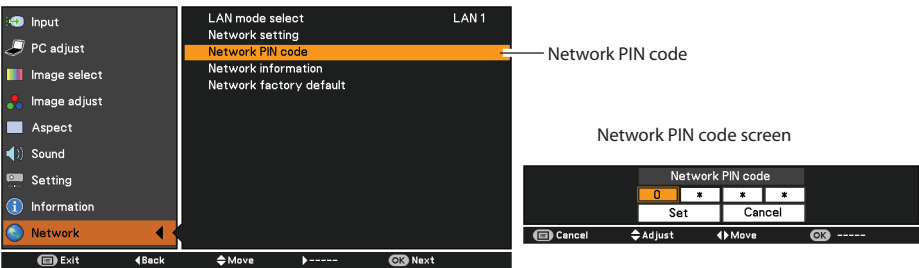

Network information

Select "Network information" in the Network menu and press Point ▶ or **OK** button to show LAN setting environment of the currently selected projector. (The description below is an example and different from what will be shown.)

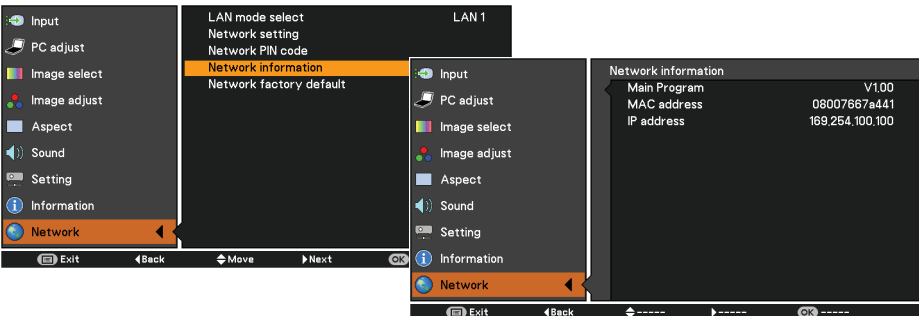

* The numerical value is a setting example.

Network factory default

1. Select "Network factory default" in the Network menu and press **OK** button.
2. A confirmation box appears and select "Yes" and then press **OK** button.
3. Another confirmation box appears and select "Yes" and then press **OK** button.
4. All the wired LAN settings will go back to the factory default settings. For details, refer to "Wired LAN factory default settings" (p.16).



Wired LAN factory default settings

.....

Parameter	SELECTED LAN		
	LAN 1	LAN 2	LAN 3
DHCP	OFF	ON	OFF
IP ADDRESS	169.254.100.100	192.168.100.100	192.168.100.100
SUBNET MASK	255.255.0.0	255.255.255.0	255.255.255.0
GATEWAY ADDRESS	255.255.255.255	255.255.255.255	255.255.255.255
DNS ADDRESS	255.255.255.255	255.255.255.255	255.255.255.255

3

Chapter 3 ***Basic Setting and Operation***

Describes basic operations and settings for controlling the projector by using the web browser. It is required that computer and projector is connected to the network and the network address is properly configured.

Login the setting page of the projector

[1] Enter the IP address

Launch the web browser installed in your computer, enter the IP address into the "Address" on the browser and then press "Enter" key.

Enter the address that you configured in item "Network configuration" (p.12).

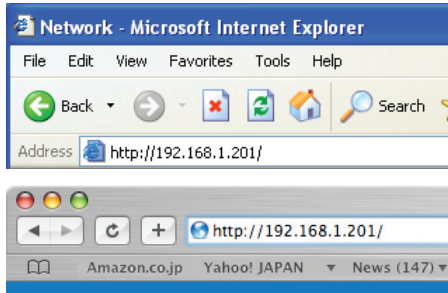

* The numerical value is a setting example.

[2] Login

If the setting page has set the password, the authentication window will appear. In this case type "user" onto the **User name** text area and the login Network PIN code onto the **Password** text area and then click **OK (Log in)** button.

* The entering User Name must be "user" and it can not be changed.

[Note]

When accessing the projector for the first time or the Network PIN code "0000" is set, the auto-login will be performed and the next main setting page is displayed.

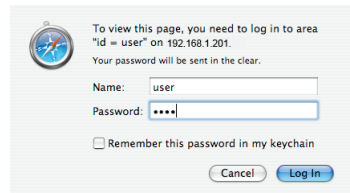
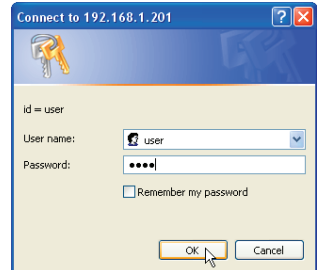

[3] Display of main setting page

The following main setting page will be displayed according to your display mode selection. Perform various kinds of settings through this page. Click on the menus to display the control and setting pages.

Main setting page in the display

The screenshot shows the projector's main setting page. On the left is a vertical 'Main menu' with icons and labels: Initial setting, Power & Status, PC Adj., Control, Setting, E-mail setting, Network, Information, and SNMP setting. The 'Control' menu item is highlighted. The main area displays the 'Control' sub-menu with various settings: Contrast (32), Brightness (32), Color (32), Tint (32), Color temp. (Mid), White balance (Red, Green, Blue), Sharpness (8), Gamma (8), Noise reduction (L1), Progressive (L1), Reset, Store (User), and Load image mode (Standard). Each setting has a 'Set' button and a small up/down arrow. A 'Sub menu tab' is located at the top of the main area, with a callout box stating 'Switches the sub menu tab.' Below the screenshot, two callout boxes describe the 'Main menu' and 'Setting page'.

Main menu
For selection of control and setting items of the projector.

Setting page
Displays the control and setting items according to the selected menu.

Sub menu tab
Switches the sub menu tab.

How to use the setting page

To control and set up the projector, use the setting menus on the web browser. Describes the basic operation and procedures commonly used on this manual.

Example of the setting page

The setting menu appears when clicking the sub menu tab.

* Each item has a valid setting range respectively.



Types of setting

Text box setting

Enter a number or text and then click **Set** button.

or

Change a value with – or + button.

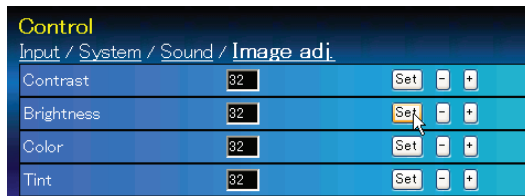

Pull-down menu setting

Select an item with pull-down menu button and then click **Set** button.

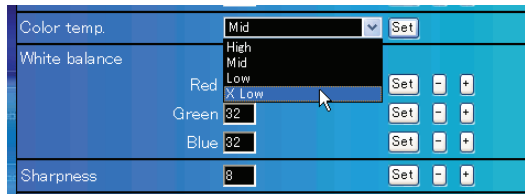

☞ The value in the text box indicates current value.

☞ Each item has a valid setting range. The setting value exceeding this becomes invalid. Some control items can not be used depending on the selecting input mode or functions of the projector you use. In this case, the values of those items are indicated with "---".

Radio button setting

Select an item by selecting a radio button.

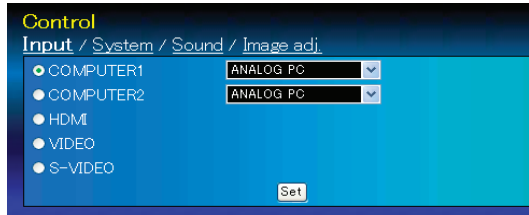

Check box setting

Select items by ticking on check boxes.

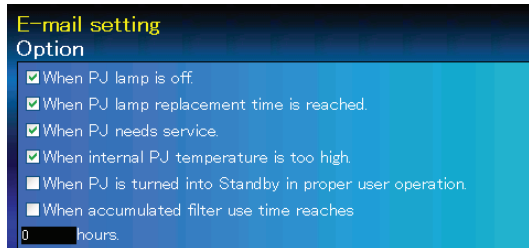



Initial setting

After installing the projector, perform the following basic initial setting. Click **Initial setting** on the main menu to display the initial setting page.

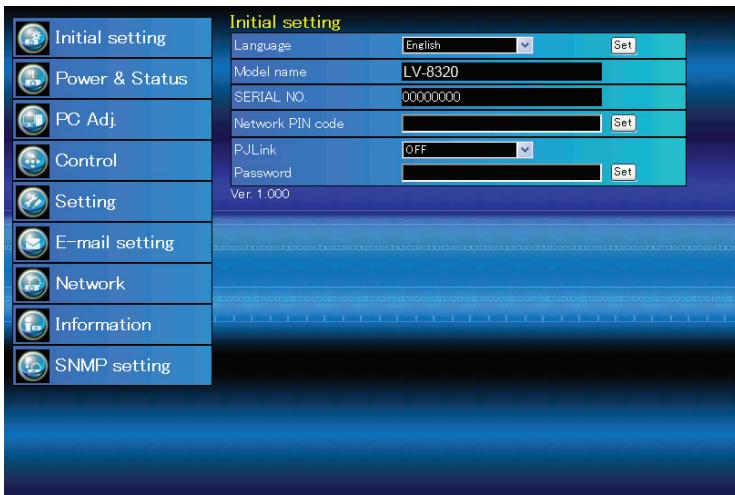

* The serial number in the figure is used for an example.

Item	Description
------	-------------

- | | |
|------------------------|--|
| Language..... | Switches display language on the setting page. (Japanese, English) |
| Model name | Indicates the model name of the projector. |
| SERIAL NO. | Indicates the serial number of the projector. |
| Network PIN code | Sets the Network PIN code to login the setting page. (☞p.23) |
| PJLink..... | Switches PJLink password authentication. (ON, OFF) (☞p.23) |
| Password..... | Password for PJLink function. (☞p.23) |

Network PIN code setting

This is to set the Network PIN code to restrict the access from an unauthorized person through the network.

Enter a 4-digit number as the Network PIN code onto the text box and click **Set** button.

The projector begins restarting and it takes about 10 seconds. Close (Quit) the web browser and access to the login page again in 10 seconds. This is to perform the login authentication firmly.

The default Network PIN code [0000] means no Network PIN code is set.

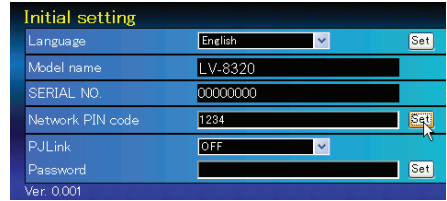

☞ When you connect the projector to the network, it is recommended to set a new Network PIN code. Only a four-digit number is valid for the Network PIN code.

PjLink and password setting

This is to set the PjLink password authentication on or off. If set "ON" with the PjLink pull-down menu, the password must be required. Enter a **password*** onto the text box and click **Set** button.

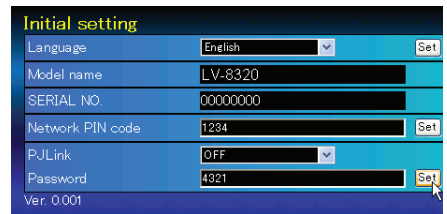

*1 to 32 alphanumeric characters can be used for the password.

What's PjLink?

The projectors equipped with PjLink function can be used together on the same network, regardless of model or brand, for centralized control and monitoring. This standard was established by the Japan Business Machine and Information System Industries Association (JBMIA). Please visit the Website at <http://pjlink.jbmia.or.jp/english/>.

PjLink Notice

The projector is compliant with PjLink Standard Class 1 of JBMIA, and it supports all commands defined by PjLink Class 1 and is verified conformance with PjLink Standard Class 1.

Projector Input		PjLink Input	Parameter
COMPUTER 1	ANALOG PC	RGB 1	11
	COMPONENT	VIDEO 2	22
	SCART	RGB 2	12
COMPUTER 2	ANALOG PC	RGB 3	13
HDMI	HDMI	DIGITAL 3	33
VIDEO	VIDEO	VIDEO 1	21
S-VIDEO	S-VIDEO	VIDEO 5	25



Network configuration

Click **Network** on the main menu. The following setting page is displayed. The IP Address, Subnet Mask, Default Gateway, DNS (Domain Name Server) and projector name are set up on this menu.

The IP address and Subnet Mask have been configured already in chapter "Installation". If you want to change them or configure default gateway or DNS, perform them in this page. If you change them, the projector begins restarting and it takes about 10 seconds. Close (Quit) the web browser and access to the login page again in 10 seconds.

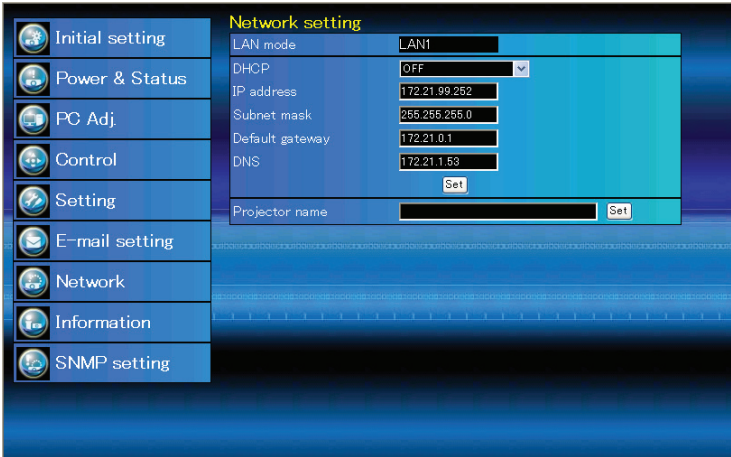

Item	Description
------	-------------

- | | |
|-------------------|--|
| LAN mode | Displays the selected LAN mode. |
| DHCP | Sets DHCP configuration. (ON/OFF) |
| IP address | Sets IP address of the projector. |
| Subnet mask | Sets Subnet mask according to your network environment. |
| Default gateway*1 | Sets IP address of the default gateway (Router). |
| DNS*2 | Sets IP address of the DNS server. Must be set when using the e-mail function. |
| Projector name*3 | Sets name of the projector. (64 characters maximum) |
- ☞ You must use the number specified by your administrator. The address must be entered as a group with four numbers split by a dot like [192.168.001.101].

*1 Set [0.0.0.0] if the network does not provide the gateway (router).

*2 Set [0.0.0.0] if you do not use the function E-Mail alert.

*3 If you use the DNS server, register the host name registered to the DNS server as a projector name. You can access with this projector name from any computers in your network. If you do not use the DNS server, access with the assigned IP address to the projector.

* All the network setting will reset to the default when setting [0.0.0.0] of the IP Address.

* If you make incorrect settings, you cannot find out the new network settings. Be careful to set up them correctly, otherwise you cannot connect to the projector. It is recommended to make a note of them.



E-mail setting

This projector has an E-mail function which can send an alert message to users or an administrator if it detects an abnormality on the projector or run out of the life span of the lamp. So must be set this E-mail setting. Click

E-mail setting on the main menu and follow the below steps.

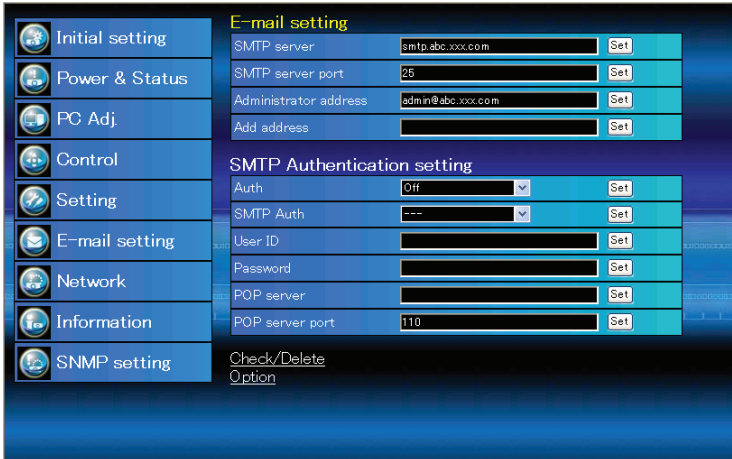

Item	Description
SMTP server	Enter server name or IP address of the SMTP server. (up to 60 characters)
SMTP server port	Enter Port number of the SMTP server. (from 1 to 65535)
Administrator address.....	Enter e-mail address of administrator.
Add address.....	Enter e-mail address of the user to send mail when the projector has an abnormality.
SMTP Authentication setting	
Auth	Sets authentication setting option. (Off, SMTP Auth, POP before SMTP)
SMTP Auth	Sets user authentication setting option when selecting "SMTP Auth" in above column. (CRAM-MD5, LOGIN, PLAIN)
User ID	Enter SMTP user ID. (up to 63 characters)
Password	Enter SMTP password. (up to 63 characters)
POP server.....	Enter server name or IP address of the POP server. (up to 60 characters)
POP server port	Enter Port number of the POP server. (from 1 to 65535)

1 Setting SMTP server and administrator address

Enter the server name or IP address of the SMTP server*, the port number of the SMTP server and administrator address and click **Set** button. The administrator address is set to "Reply-To" address of the message sent from the projector.



*1 The SMTP server is a server for sending e-mail. Please contact your network administrator to have this SMTP server address.

2 Registering and deleting E-mail addresses

Enter the e-mail address onto "Add e-mail address" and click **Set** button.

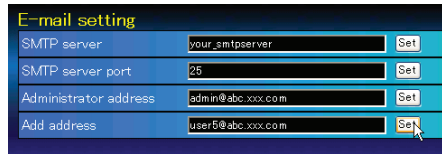





Check / Delete

To check the registered addresses, click **Check/Delete** sub menu tab. The addresses are listed as the figure on the right.

 Up to 10 E-mail addresses can be registered.

To delete the registered addresses, check the address you want to delete and click **Delete** button.



-  If the projector sends an alert message due to the abnormality on the projector but the SMTP server is down in some other reason, the message will not be sent. In this case, the message "Unable to connect to server." will be displayed on the setting page. To clear this message, set up SMTP server address again.
-  To use the E-Mail function, it must be set the DNS address on the Network setting page correctly.
-  You cannot use this E-mail function if the DNS server and SMTP server cannot be used in your network environment.
-  The projector does not send message to the address set in "Administrator address" text box. If you want to send e-mails to the administrator address, enter the administrator address into "Add address" text box.

3 Setting SMTP authentication

Set the SMTP authentication concerned and click **Set** button. Please contact your network administrator in details.

4 Setting POP server

When "POP before SMTP" is selected at "Auth" of "SMTP Authentication setting", enter "POP server*2" and "POP server port" and click **Set** button.

*2 The POP server is a server for receiving e-mail. Please contact your network administrator to have this POP server address.

If the authentication is not completed when sending alert e-mail, the error message will be displayed. Please check the respective settings.

5 Option selection for sending alert mail

Click **Option** sub menu tab. Check the condition items under which alert mail will be sent and click **Set** button.

Please refer to item "Examples :Type and contents of alert mail" described on the next page.

Option

① "When PJ lamp is off" signifies the lamp goes out without user operation. "When PJ is turned into Standby in proper user operation" signifies that the projector is turned on by using the web browser and then it is turned into standby with ON/STANDBY button on the top control or the remote control.

② Up to 99,999 hours can be set for use time.

Examples: Type and contents of alert mail

When the projector has an abnormality, the following alert messages are sent to the registered E-mail address according to your selected condition. Administrator or user can take an efficient action quickly by receiving this message.

The following are examples of received messages.

● When internal PJ temperature is too high:

TITLE: Message from projector
Projector Model Name: *model name*
TCP/IP: 192.168.1.201 Projector Name: Proj05

It sends you following message.

*The Projector lamp is turned off, because internal temperature goes over the safety limit. Wait for the completion of the cooling process and make sure the projector has been turned into Standby. Then turn the projector on again.
If the Indicator continues flashing, check the air filter for dust accumulation.

● When PJ needs service:

TITLE: Message from projector
Projector Model Name: *model name*
TCP/IP: 192.168.1.201 Projector Name: Proj05

It sends you following message.

*Maintenance requirement from Projector is detected.
Check up LED status of projector and consult with the dealer.

MCI	3.3V	OK	Error information
MAIN	ALL	NG	

 The projector lamp was turned off, because the projector power circuit failed. Unplug the AC power cord and plug it, and then turn on the projector once again to verify operation. If the problem still persists, unplug the AC power cord and ask servicing to a qualified service personnel with the error information.

● When PJ lamp replacement time is reached:

TITLE: Message from projector
Projector Model Name: *model name*
TCP/IP: 192.168.1.201 Projector Name: Proj05

It sends you following message.

*The projector lamp has reached replacement time.
Lamp ON 3000 h

 Replace it with a new lamp immediately and reset the lamp counter. If the projector is used without resetting the lamp counter, the alert mail is sent to users in every power-on of the projector. This alert mail will not be sent when unchecking the mail sending condition "When PJ lamp replacement time is reached".



SNMP setting

This projector provides a SNMP (Simple Network Management Protocol) agent function. The SNMP consists of a manager and agents. The group which communicates information each other with SNMP is called "Community". There are two access modes in a community, Refer (read only) and Set (read-write). This projector allows to use Refer (read only) only. The SNMP message informs the projector status called "Trap" to an administrator. Click **SNMP Setting** on the main menu and set up each item.

PJ information

Item	Description
Contact	Enter user name of the projector etc. (optional).
Place	Enter place of the projector (optional).
Community name(refer)	Enter community name (read only). Default name is "public".

Trap

Item	Description
Community name	Enter community name to send "Trap". Default name is "public".
Trap address	Enter IP address of the SNMP manager computer to receive "Trap".

Trap check/delete

Check and delete the trap address

Checking the registered trap address and deleting the address.

To delete the address, tick check box in front of the IP address and click **Delete** button.

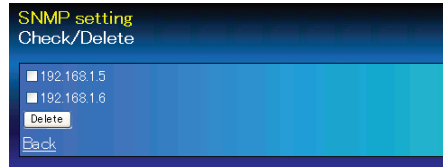

Up to 10 trap addresses can be registered.

Trap option

Trap option setting

Tick check boxes in front of the condition item to send the trap.

Click **Set** button if you tick or un-tick the check box on a page.

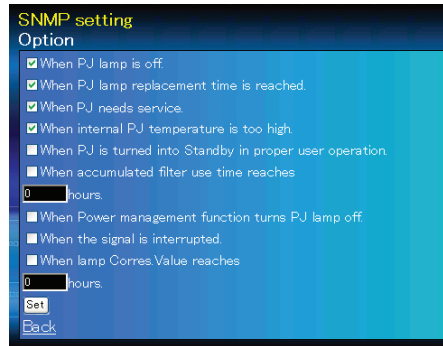

"When PJ lamp is off" signifies the lamp goes out without user operation. "When PJ is turned into Standby in proper user operation" signifies that the projector is turned on by using the web browser and then it is turned into standby with ON/STANDBY button on the top control or the remote control.

Up to 99,999 hours can be set for the time setting.

4

Chapter 4 *Controlling the Projector*

Describes controlling and setting of the projector by using the web browser.



Power control and status check

Click **Power & Status** on the main menu. The control page will be displayed.

By clicking **ON** or **Standby** button on the page, the power of the projector can be controlled.

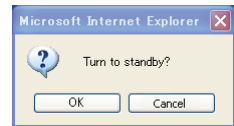
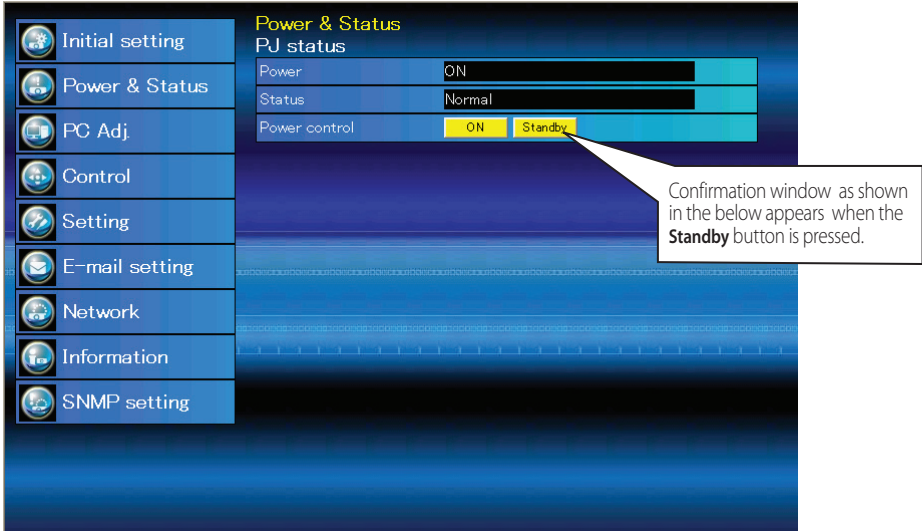

Popup confirmation window

Item	Description
------	-------------

PJ status

PowerDisplays the status of the lamp. (ON, OFF, On starting up, On cooling down, Service in need)

StatusDisplays the status of the projector's power. (Refer to next page.)

Power controlControls the projector power by clicking the "ON" or "Standby" button.

- ✎ The projector cannot be turned on while the projector is on cooling down.
- ✎ The web browser checks and updates the projector's condition every 30 seconds automatically.

About projector condition

Status	Description
Normal.....	Projector is operating normally.
Power management in operation.....	Power management is operating.
Lamp failure.....	Lamp failure is occurring.
Abnormal Temperature.....	The temperature of the projector became too high.
Standby after Abnormal Temp.....	Projector detects abnormal temp. and sets into standby mode.
Power failure	Power failure has occurred inside the projector. Projector is turned off. Unplug the AC cord and ask servicing to a qualified service personnel.

When a security (PIN code lock) has been set on the projector, you also cannot control it through the network. To control the projector through the network, unlock the security on the projector using with the projector's menu control.

Caution about turning on/off the projector via the networks

When turning on/off the projector via the networks, preset the projector as follows:

1. Select "Setting" from the Projector menu.
2. Select "Standby mode" from the Setting menu and set it as "Network".

If you set this function as "Network", the network part of the projector is constantly provided with power even if the projector is turned off. If you set this as Eco, then the network part will be turned off when you turn off the projector. Consequently, you cannot turn on/off the projector via the networks.



Control

Click **Control** on the main menu. The setting method differs depending on the contents of the page. Click on the page number to change pages and select desired setting items.

Please see the user's manual of the projector to have the further information of each control item.



Input

This function is to select the input mode and source mode of the projector. Click **Set** button after selecting the input and source mode.

Item	Description
Input.....	Selects input mode of the projector.
Source.....	Selects signal source of the input.
COMPUTER 1 :	ANALOG PC COMPONENT SCART
COMPUTER 2 :	ANALOG PC HDMI VIDEO S-VIDEO

The control page displays valid control items depending on the selected input mode, signal or functions of the projector you use, therefore, there may be different controls between the described items and actual control items on the page display. For further information , refer to the projector's user's manual.

When the projector is in standby, all the controlling items are inactive.

System

This function is to select the system of signal input to the projector. The available system mode are listed on the pull-down menu button according to the input signal. Select a system and then click **Set** button.

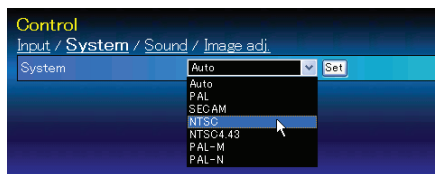

Available selection at the ANALOG PC input

Item	Description
XGA1	It automatically switches to the proper computer system of the input signal. * The computer system modes (VGA, SVGA, XGA, SXGA, UXGA, WXGA...) which meet the input signal are listed.

Available selection at the HDMI input

Item	Description
D-XGA.....	It automatically switches to the proper computer system of the input signal. * The computer system modes (D-VGA, D-SVGA, D-XGA, D-SXGA1...) which meet the input signal are listed.
D-480p.....	It automatically switches to the proper scanning system of the input signal. * The selectable scanning systems are D-480p, D-575p, D-720p, D-1035i, D-1080i and D-1080p.

Available selection at the VIDEO/S-VIDEO/SCART input

Item	Description
AUTO.....	It automatically switches to the proper color system of the input signal. * The selectable color systems are PAL, SECAM, NTSC, NTSC4.43, PAL-M and PAL-N. * AUTO is fixed at the Scart input.

Available selection at the COMPONENT input

Item	Description
AUTO.....	It automatically switches to the proper scanning system of the input signal. * The selectable scanning systems are 480i, 575i, 480p, 575p, 720p, 1035i and 1080i.

☞ If the mode (Mode1 to Mode10) which is stored in the item "PC Adjustment" (p.38) is available, they are also listed together with the above mode.

Sound

This function is to adjust the sound of the projector. The values in the text box represent the current control value or status.

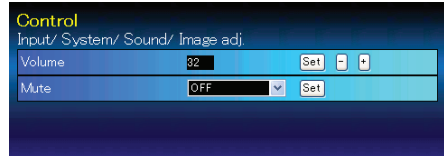

Item	Description
Volume	Adjusts the sound volume from the speaker. (0 ~ 63)
Mute	Suppresses the sound. (ON, OFF)

 The MIC functions **MIC**, **MIC GAIN**, **STANDBY MIC OUT** cannot be selected through the network. When using the MIC functions, please set by using the On Screen Menu of the projector.

Image adjustment

This function is to adjust the projected picture image and save the image mode. To store the adjusted value, click **Store** button, and to load the adjusted value, click **Load** button.

Item	Description
Contrast	Adjusts picture contrast. (0~ 63)
Brightness	Adjusts picture brightness. (0~ 63)
Color	Adjusts picture color saturation. (0~ 63)
Tint	Adjusts picture hue. (0~ 63)
Color temp.....	Sets a color temperature mode. {High, Mid, Low, X Low, User, Blackboard(Green), Colorboard}

White balance
Red, Green, Blue Adjusts each white balance respectively. (0~ 63)

* When changing the value of the white balance, the color temp. indicates "User".

Sharpness.....Adjusts picture sharpness. (0~ 15)

Gamma.....Adjusts brightness of darker part of the picture. (0~ 15)

Noise reductionSwitches noise reduction mode. (OFF, L1, L2)

Progressive.....Switches progressive mode. (OFF, L1, L2, Film)

Reset.....Resets the Image adjustment to previous levels.

Store.....Stores the Image adjustment values. Select an item [User1 - User4] from the pull-down menu and click **Store** button.

Load image modeLoads the Image mode. Select an image mode from the pull-down menu and click **Load** button. {Presentation, Standard, High contrast, Cinema, Blackboard(Green), Colorboard, User1 - User4}





PC adjustment

Click **PC Adj.** on the main menu. This function is to adjust the signal from the computer connected to the projector to obtain the proper picture image on the screen.

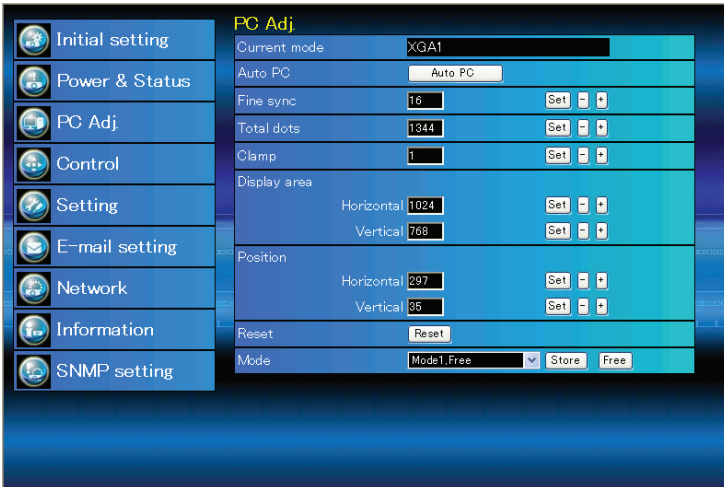

Item	Description
Current mode	Displays a current mode like VGA, SVGA, XGA, SXGA, UXGA, WXGA, etc. or Mode1 - Mode10 which are the customized mode created by using the "Mode Store" function described below.
Auto PC	Performs automatic adjustment.
Fine sync	Performs Fine Sync adjustment. (0 ~ 31)
Total dots	Adjust the number of total dots in the horizontal period.
Clamp	Adjusts the phase of the clamp.
Display area	
Horizontal	Adjusts the image area horizontally.
Vertical	Adjusts the image area vertically.
Position	
Horizontal	Adjusts the horizontal position of the screen.
Vertical	Adjusts the vertical position of the screen.
Reset	Resets the PC adjustments to the previous levels.
Mode Store	Stores the PC adjustment values. Select a mode no. [Mode1 - Mode10] from the pull-down menu.
Mode Free	Clear the PC adjustment values. Select a mode no. [Mode1 - Mode10] from the pull-down menu.



Setting up the projector

Click **Setting** on the main menu. This function is to set up the projector. Select the sub menu [Aspect setting] or [Setting] and then set up each setting.

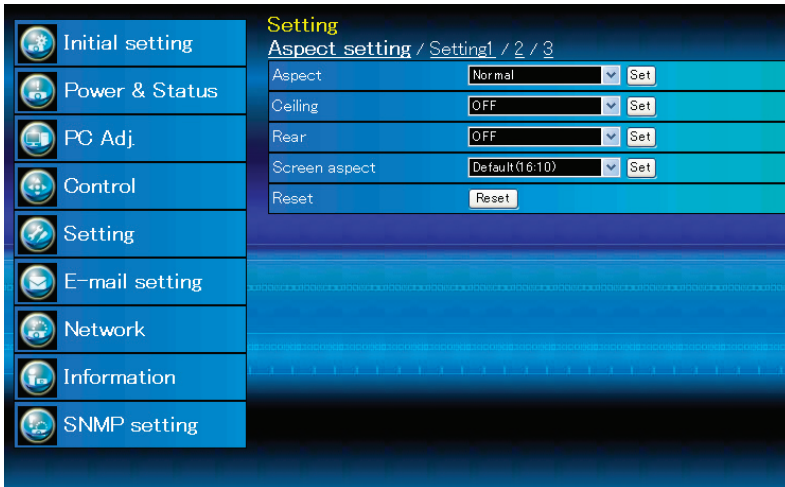

Aspect setting

This function is to adjust the aspect mode of the projector. The values in the text box represent the current aspect status.

Item	Description
Aspect	Switches the aspect mode. (Normal, Full, 16:9, Zoom, True, Natural wide, Custom) There may not be available mode depending on the input mode as shown in the table below.
Ceiling	Sets the image top/bottom and left/right reversed. (ON, OFF)
Rear	Sets the image left/right reversed. (ON, OFF)
Screen aspect	Sets the aspect. {Default(16:10), 16:9, 4:3}
Reset	Resets the Screen settings.

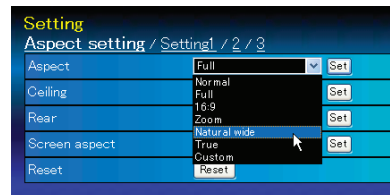

Screen Aspect	Default(16:10)		16:9		4:3	
	Video	PC	Video	PC	Video	PC
Aspect mode	Video	PC	Video	PC	Video	PC
Normal	✓	✓	✓	✓	✓	✓
Full	✓	✓	✓	✓	✓	✓
16:9	✓	✓	*1	*1	✓	✓
Zoom	✓	✓	✓	✓	✓	✓
True	*1	✓	*1	✓	*1	✓
Natural wide	*2	*1	*2	*1	*1	*1
Custom	✓	✓	✓	✓	✓	✓

✎ The mark "✓" means that the available aspect mode in the selected input source system.

*1 The error message appears when selecting the disabled aspect mode indicated with "*1".

*2 Natural wide cannot be selected when 720p, 1035i, 1080i or 1080p is selected in AV system menu.

Setting 1

Item	Description
Language.....	Sets the language display of projector's on-screen display menu.
Auto setup.....	Executes the Auto input, Auto PC, and Auto keystone functions below according to the each setting after clicking Start button.
Auto input.....	Sets the auto-input signal detection mode. (ON1, ON2, OFF)
Auto PC.....	Sets the auto PC adjustment mode. (ON, OFF)
Auto keystone....	Sets Auto Keystone mode. (Auto, Manual, OFF)
Background.....	Sets the screen background when no signal input. (Blue, User, Black)
Display.....	Switches on or off the on-screen menu display on the screen. (OFF, Countdown off, ON) Countdown off.....Displays image during the starting up.
Logo.....	Sets on or off the logo display on the screen during the startup. (OFF, Default, User)



Setting 2

Item	Description
Terminal.....	Sets the COMPUTER IN 2/MONITOR OUT terminal. (COMPUTER2, Monitor out)
Picture in picture.....	Select the picture in picture mode.(P in P, P by P, OFF)
Power management mode.....	Sets into the selected power management mode (Standby, Exit, OFF) if the input signal is interrupted and no control key is pressed for the specified period of time. *The specified time can be set 1 to 30 min.
Direct power on.....	Sets the power-on mode when the AC cord is connected to the outlet. (ON, OFF)
Lamp mode.....	Selects lamp control mode. (Auto, Normal, Eco1, Eco2)
Lamp life control.....	Selects lamp life control mode (Mode1, Mode2) when the total use time exceeds the recommended total hours of use.
Key lock.....	Sets the prohibition of controls either Projector or Remote control. (OFF, Projector, Remote control)
Fan control.....	Sets the fan control speed. OFF Normal mode ON1 Highland mode 1 ON2 Highland mode 2

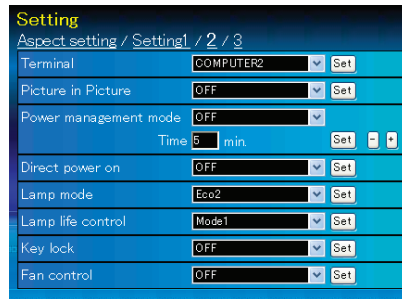

Setting 3

Item	Description
------	-------------

Filter counter(h)	Displays the filter counter. Reset the time after filter clean-up. Click "Reset", a confirmation display appears, and then click "OK", the time will be reset.
Filter warning	Sets the time to indicate the filter warning message on the screen. (OFF, 1000H, 2000H, 3000H, 4000H, 5000H, 6000H)
Total power savings	Displays the total accumulated power savings of the projector and the total amount of CO2 exhausted from the projector. Click "Reset", a confirmation display appears, and then click "OK", the figures will be reset.
Factory default	Sets all of the projector control items to the factory default setting except the following items. User Logo, Logo PIN code lock, PIN code lock, Lamp Corres. Value, Filter counter, PJ time * This function is effective for all the Network settings.
Blank	Sets the black out image temporarily. (ON, OFF)
Freeze	Sets the image to freeze mode. (ON, OFF)
Closed caption	Sets the closed caption function. Closed caption...Sets the closed caption mode. (OFF, CC1, CC2, CC3, CC4) ColorSets the color of the contents. (Color, White)

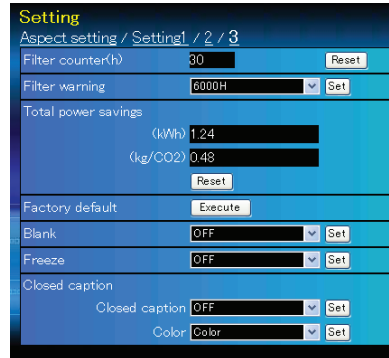



Information

This page is to display the basic information of the projector status. Click **Information** on the main menu.

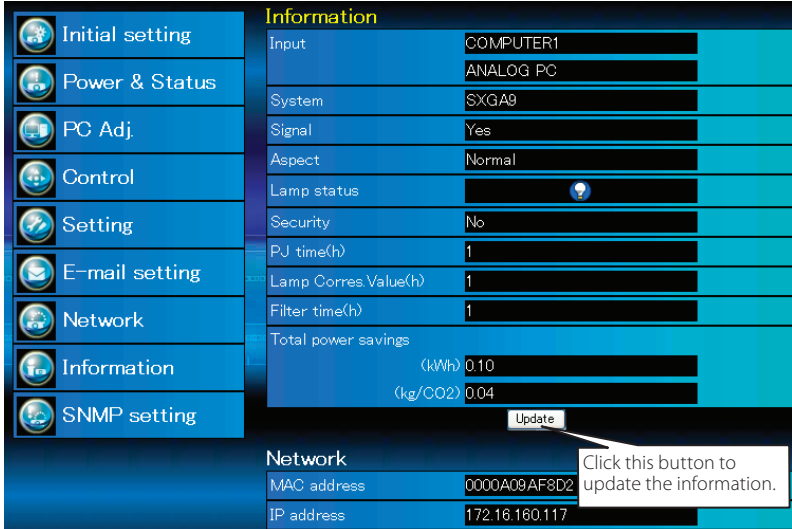







Information

Items	Description
Input.....	Displays selected input and source.
System.....	Displays selected signal system.
Signal.....	Input signal status. (Yes, No)
Aspect.....	Displays aspect mode.
Lamp status.....	Displays lamp status with an icon. Refer to the table on the next page.
Security.....	Displays the security (PIN code lock) status. (Yes, No)
PJ time(h).....	Displays the accumulated use time of the projector.
Lamp Corres. Value(h).....	Displays the use time (Corresponding value) of the lamp.
Filter time(h).....	Displays the accumulated use time of the filter.
Total power savings.....	Displays the total accumulated power savings and the total amount of CO2 exhausted from the projector.

Network

Items	Description
MAC address.....	Displays MAC address of the projector.
IP address.....	Displays the IP address of the projector.

Indication of the lamp status

Icon display/background	Status
 White/Blue	Lamp on (Normal)
 White/Red	Lamp on (Lamp is being used over a specified use time, replace lamp immediately)
 Gray/Blue	Lamp off (Normal)
 Gray/Red	Lamp off (Lamp is being used over a specified use time, replace lamp immediately)
 Red/Blue with X	Lamp failure (Lamp failure, check lamp condition)
 Red/Red with X	Lamp failure (Lamp failure and lamp is being used over a specified use time, replace lamp immediately)

5

Chapter 5 *Appendix*

Examples of connection

Use of telnet

Web browser setting

Q & A

Menu Tree

Examples of connection

Peer-To-Peer connection

Connecting the projector (PJ01) to the control computer (PC05) directly.

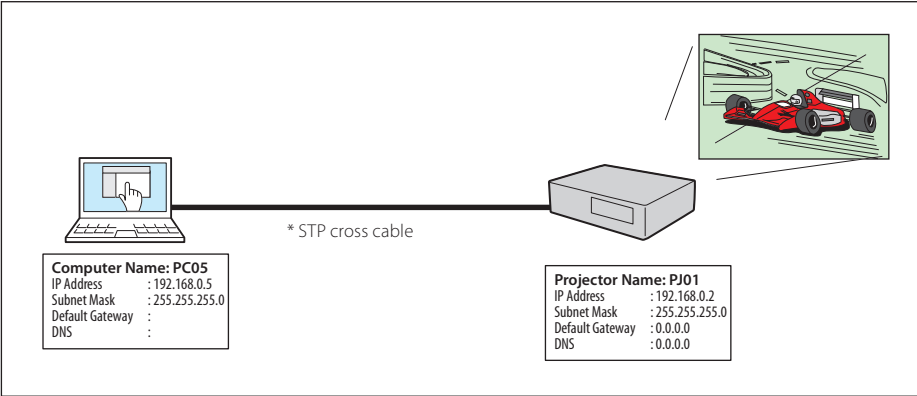

Connecting the projector (PJ01) to the control computer (PC05) via the hub.

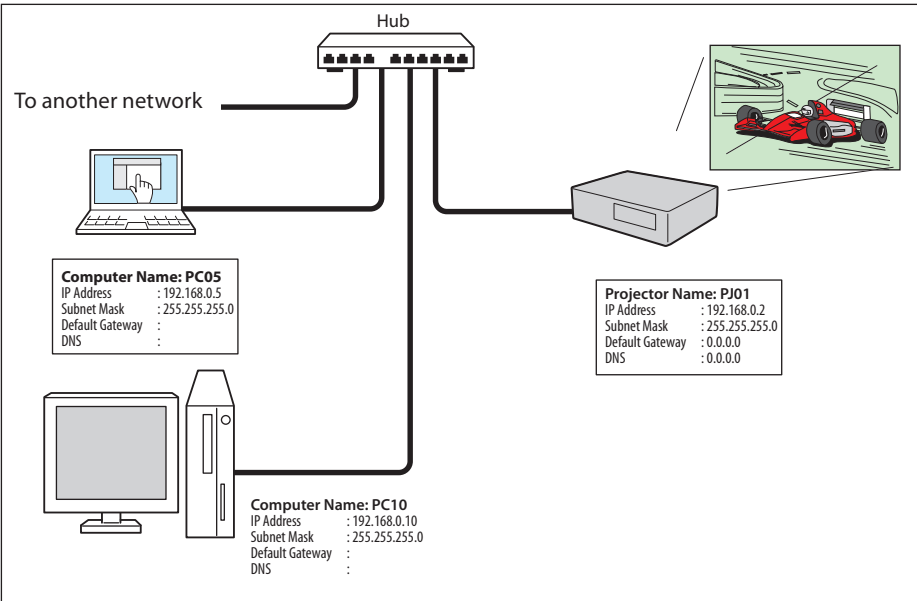

When the projector is connected to the computer directly without hub, the STP cross cable should be used.

The gateway (Router) installed in the network

Connecting the projector (PJ01) to the control computer (PC05) via the gateway.

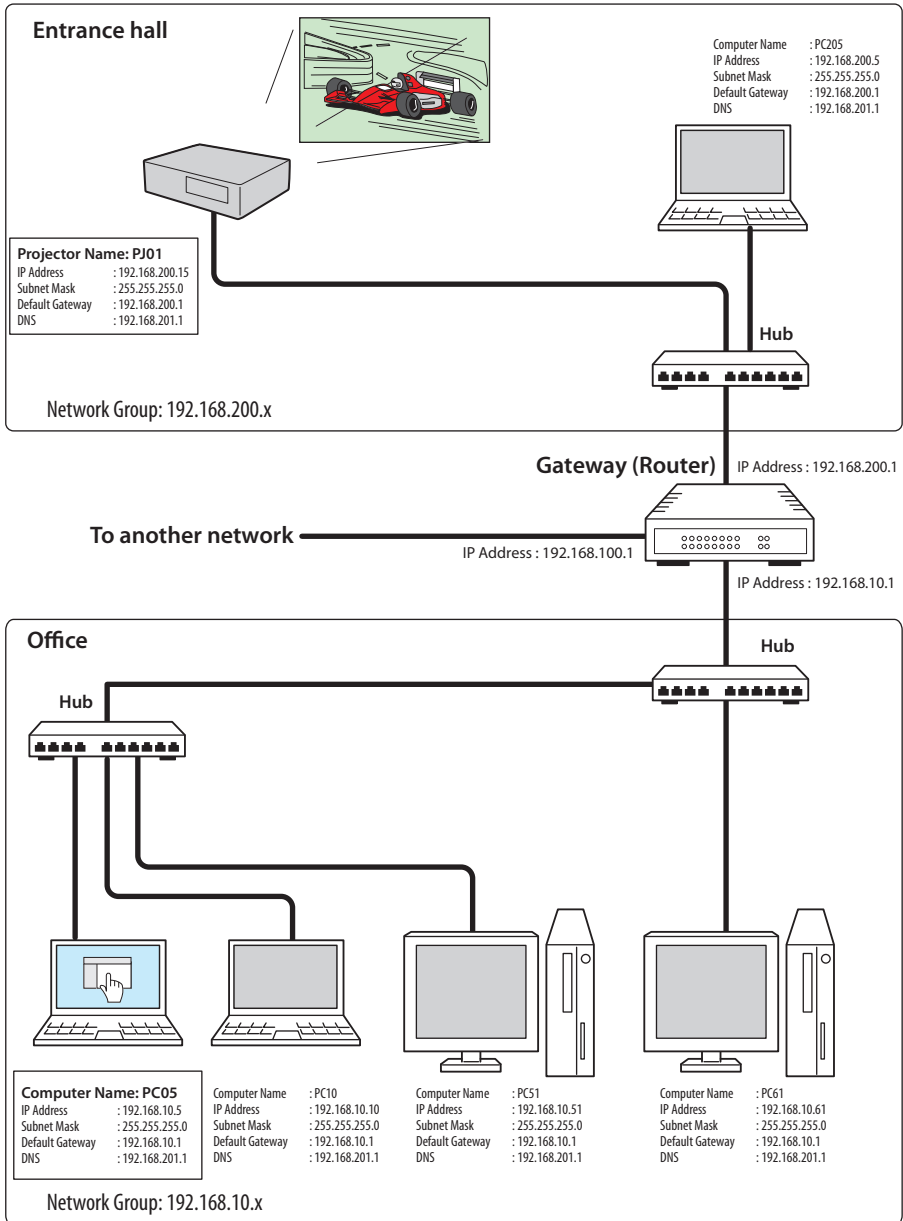

Use of telnet

You can control the projector by using the telnet application¹ installed on your computer. Normally, the telnet application is available on your computer.

* The telnet 10000 port is used to control the projector.

Control

(For example, in case of using the telnet application of **Windows XP Professional**.)

1. Select **Run...** submenu from **Start** menu on the computer. Type "telnet" onto the **Open** text area on the displayed window and press **OK** button.

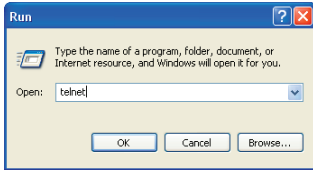

(For example, in case of using the telnet application of **Mac OS X v 10.4**)

1. Select **Terminal** from **Applications -->Utilities**.

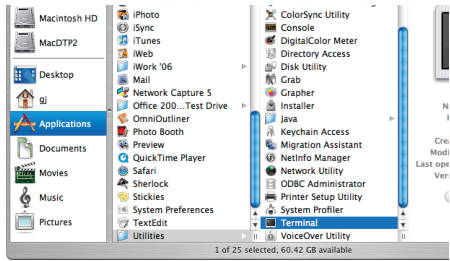

Type as below on the displayed window.
> telnet [return]

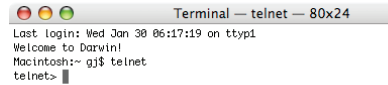

2. The telnet application will start and the following window will be displayed. Type as below to connect the projector.

> open 192.168.1.201 10000 [return]

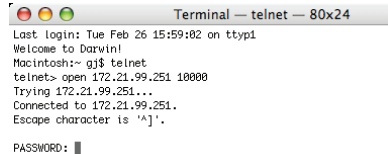
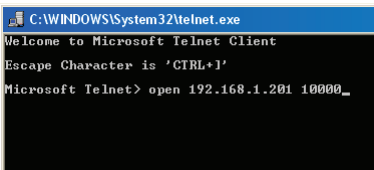

* Use the IP address assigned to the projector.

3. When communication is established correctly, the word "PASSWORD:" appears on the window. Type the login password (Network PIN code²) for the projector and then press "Enter" key on the keyboard. If you do not set up the Network PIN code, just press "Enter" key.

When the word "Hello" is replied, login has been succeeded.

* The password "1234" is used for the example.

```
Telnet 192.168.1.201
PASSWORD: 1*2*3*4*
Hello
```

```
Terminal — telnet — 80x24
Last login: Tue Feb 26 16:03:39 on ttty1
Welcome to Darwin!
Macintosh:~ gj$ telnet
telnet> open 172.21.99.251 10000
Trying 172.21.99.251...
Connected to 172.21.99.251.
Escape character is '^'.

PASSWORD: 1234

Hello
```

4. Type the commands, refer to below table, to control the projector and then press "Enter" key for termination. For example, type "C00" which is a command to turn on the projector, and press "Enter" key. Confirm the projector is turning on.
- * Enter with ASCII 64-byte capital characters and one-byte characters.

To disconnect the communication, press "Ctrl" key and "]" key at the same time, type "close" and then press "Enter" key on the Keyboard.

> close [return]

The table below shows the typical command lists for controlling this projector and please consult your local dealer for further information of another commands.

Command list table

Command	Function
C00	Power on
C02	Power off
C09	Volume up
C0A	Volume down
C0B	Audio Mute on
C0C	Audio Mute off
C1C	Menu display on
C1D	Menu display off

*1 Further instructions about the telnet application, please see the on-line guide on your computer.

*2 The password is a Network PIN code decided item "Network PIN code setting" (p.14, 23). If the authentication of the entered password is failed 4 times continuously, the communication will be disconnected automatically. Please try again for the connection.

☞ If the password or any command is not entered for more than 30 seconds, the communication will be disconnected automatically. Please try again for the connection.

Web browser setting

This projector is designed to be set up and controlled from an Internet web browser. Depending on the preference settings of the web browser, some control functions may not be available. Please make sure that the following functions are set up properly in the web browser.

Active Script/JavaScript enable

There are some control items used with the JavaScript function in the setting pages. If the web browser is set not to use this JavaScript function, it may not control the projector properly. In this case, the warning message "Make sure JavaScript is ON." will be displayed on the top of the page. To enable the JavaScript, please see further instructions on the next page.

Proxy setting

In some cases, your web browser is set up to use the proxy server for the internet or intranet connection. In this case, when you install this projector into the local network, you should set up the proxy setting of web browser preference correctly. Especially when connecting the projector and computer with a STP cross cable directly, or when the network does not provide the proxy server, make sure that "not use proxy server" is set up in your web browser preference. Please see item "Examples: OS/Browsers" in the next page for further setting up procedure.

 There are various ways to change your browser preferences depending on the version or applications. Please see the setting instructions on next page for example and also refer to on-line help of your web browser.

Examples: OS/Browsers

Windows XP Professional

Internet Explorer v.6.0

ActiveScript setting

Select **Internet Options** from **Tools** menu on the web browser and then select **Security** tab and click **Customize Level...** button. On the security setting window, scroll down and find the **Scripting** item, make sure that "Enable" is selected in item **Active Scripting**.

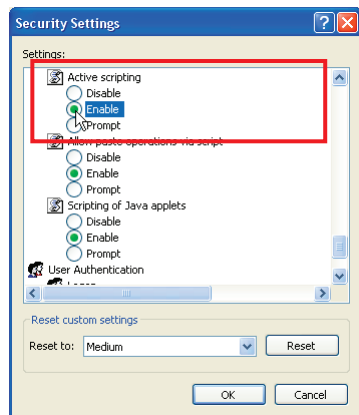
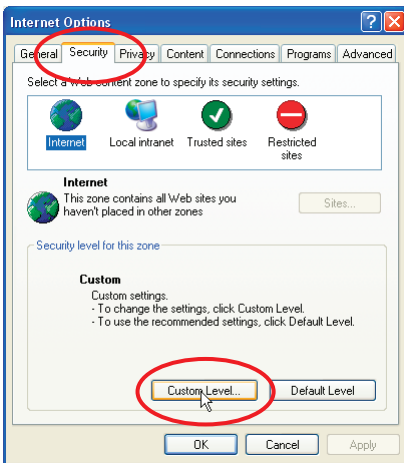

Proxy setting

Select **Internet Options** from **Tools** menu on the web browser and then select **Connection** tab and click **LAN Settings** button. Properly set up your web browser's the proxy server settings according to the local area network environment to which the projector is connected.

- Using proxy server

To use an external internet connection from the local area network, check the item **Use a proxy server** and enter the proxy server address and port correctly in the proxy settings window. For further instruction please consult your network administrator.

- Not using proxy server

Uncheck the item **Use a proxy server**.

If you connect the projector to the computer directly with STP cross cable, this must be unchecked.

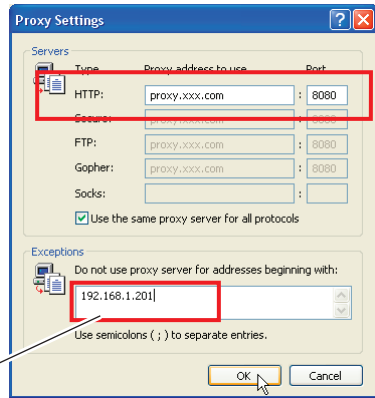
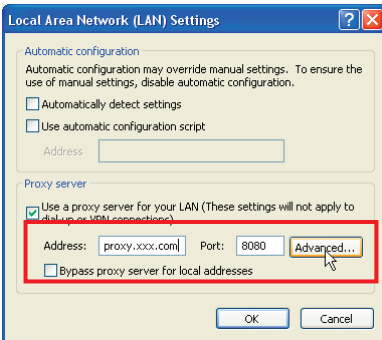

To designate proxy settings that will not use the proxy server when accessing the projector installed in the local area network, enter the IP address or domain name here.

Netscape Navigator v.7.1

JavaScript Setting

Select **Preference** from **Edit** menu on the web browser and then select the item **Advanced/Scripts & Plugins** in the **Category** column. Make sure that the **Enable JavaScript for Navigator** is checked.

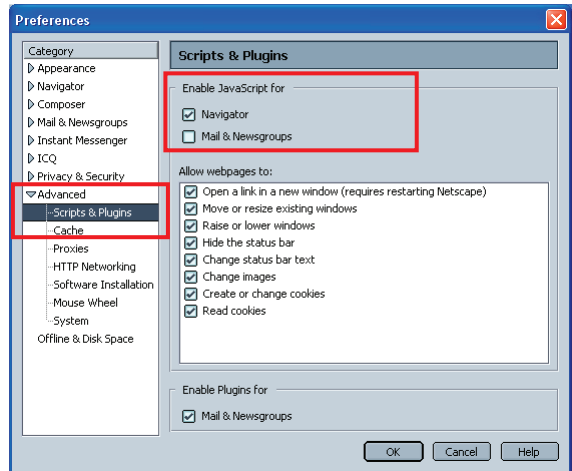

Proxy setting

Select **Preference** from **Edit** menu on the web browser and then select the item **Advanced/Proxies** in the **Category** column. Properly set up your web browser's the proxy server settings according to the local area network environment to which the projector is connected.

- Using proxy server

When you use an external internet connection from the local area network, select the item **Manual proxy configuration**. Enter the proxy server address and port number correctly on **HTTP Proxy** item. For further instruction please consult your network administrator.

- Not using proxy server

Select the item **Direct connection to the Internet** in the proxy setting window. If you connect the projector to the computer directly with STP cross cable, this must be selected.

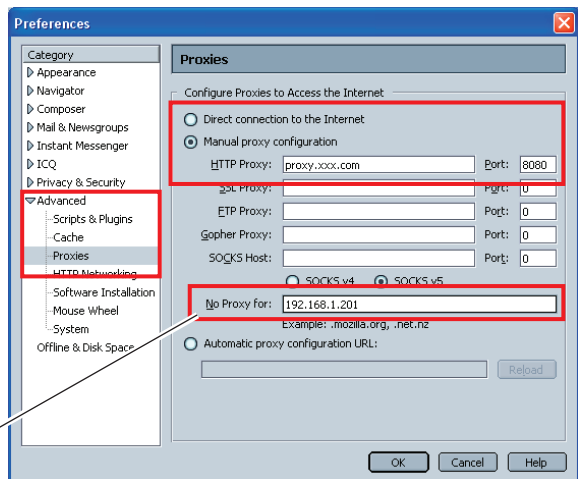

To designate proxy settings that will not use the proxy server when accessing the projector installed in the local area network, enter the IP address or domain name here.

MAC OS X v 10.4

Safari v.3.2.1

JavaScript enable setting

Select **Preferences...** from **Safari** on the web browser and then select **Security** tab and check **Enable JavaScript**.

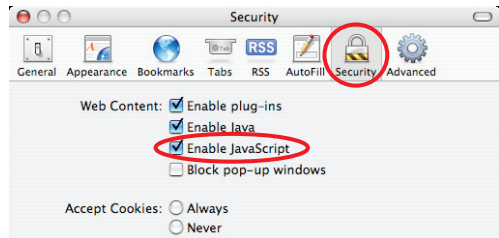

Proxy setting

- 1 Open **Preferences...** from **Safari** menu on the web browser **Safari**. The preference menu appears.
- 2 Select **Advanced** icon and then click **Proxies: Change Settings ...**
- 3 Select **Proxies** tab and properly set up your web browser **Safari**'s the proxy server settings according to the local area network environment to which the projector is connected.

- Using proxy server

To use an external internet connection from the local area network, check the items **Web Proxy (HTTP)** and **Secure Web Proxy (HTTPS)** of **Select a proxy server to configure** window and enter the proxy server address and port correctly in **Web Proxy Server** window. For further instruction please consult your network administrator.

- Not using proxy server

Uncheck the items **Web Proxy (HTTP)** and **Secure Web Proxy (HTTPS)** of **Select a proxy server to configure**. If you connect the projector to the computer directly with STP cross cable, they must be unchecked.

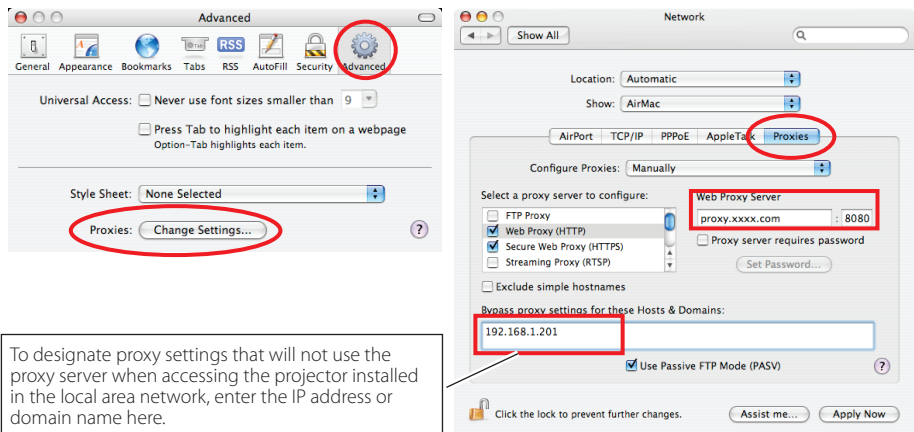

To designate proxy settings that will not use the proxy server when accessing the projector installed in the local area network, enter the IP address or domain name here.

Q&A

Installation/Access

Q *Why doesn't the setting page appear in my web browser?*

- A** Following causes are possible. Please check them.
1. The projector does not connect to the network.
Check LED indicators status (☞ p.12).
 - Check the connection of LAN cable if the LINK Lamp does not light green.
 - Check the network configuration of the projector if the ACT Lamp does not blink orange.
 2. Wrong network configuration of the computer.
Check the network configuration of the computer.
 3. The proxy setting of the web browser is not set correctly (☞ p.52).
 4. The computer does not provide TCP/IP protocol.

Q *How can I restrict access from the computer.*

- A**
1. Please use the password authentication function on the login page (☞ p.23).
 2. Please use the IP filtering function provided with the gateway (router) to restrict the accessing from the computer. For further information please consult your network administrator.

Q *Can I access the projector installed on the company's local area network from a remote location?*

- A** There are some ways to access to the projector in the LAN, but you must consult your network administrator for security reason.
- ☞ Use of modem
(Connect to the company's network from your home or some other places by using modem.)
 - ☞ Use of private line
(Connect to the company's network from the branch office or maintenance office by using private line.)
 - ☞ Use of internet
(Connect to the company's network from your home, branch office or some other places by using the internet.)

Q *We use the DHCP/BOOTP server to assign the IP address. Is it possible to use the projector in this network environment?*

A Possible. This projector supports the DHCP/BOOTP server. To use this projector in this network environment, set it up so that the DHCP/BOOTP server does not assign the IP address configured to this projector for another device on the network. Please consult your network administrator (☞ pp.13, 24).

Q *How can I install several projectors?*

A Install and configure network one by one to avoid the IP address collision each other. To configure the IP address please see item "Network configuration" (☞ pp.12-13, 24).

Password/Login

Q *What should I do when I forget the IP address of the projector?*

A You can check the IP address in the "Network information" menu.

Q *What should I do when I forget the password (Network PIN code)?*

A Please set the new network PIN code in the "Network PIN code" menu.

Q *Can I register the setting page as a web browser "Favorites" or "Bookmarks"?*

A Please add "Login" page to your "Favorites" or "Bookmarks". Do not add the specified setting page because it will not be able to perform the password authentication correctly.

Operation

Q *Why can't be turned on/off with web browser?*

A Please make sure the settings of the projector are correct to use the projector. Please set the **Standby mode** of the projector's **Setting menu** to "**Network**". Refer to "4. Controlling the Projector" → "Power control and status check" (☞ pp.32 - 33).

Q *Why can't I change the controls in the setting page with web browser?*

A Please make sure the projector is turned on. If it is in the standby mode, the setting is not effective to the projector. To control the projector with a web browser, the projector must be in the powered-on condition.

Q *Why does it sometimes take a lot of time to complete the page display?*

A The display speed of the page depends on the network environment in which both the projector and computer are placed. It may take much time to complete the page display if network traffic is heavy. Please consult your network administrator.

Q *How many numbers of the E-mail address can I register in the E-mail setting page.*

A You can register up to 10 addresses.

Q *Why am I not receiving E-mail alert messages?*

A Make sure that the registered E-mail address and SMTP server address are correct. If the SMTP server is located in your LAN (Local Area Network), the address should be set to the SMTP server in your LAN. The SMTP server located outside of your LAN may not be available for security reason. For further information please contact your network administrator (☞ p.25).

Others

Q *What are the rules for IP address assignment?*

A If the network is constructed with TCP/IP protocol, a unique IP address is required for each piece of network equipment. The following are basic rules of the assignment.

Rule1

Do not configure the same IP address to the network equipment in the same network group. Each piece of equipment must be assigned a unique IP address.

If the IP address is set [192.168.x.x], the Subnet Mask should be set [255.255.255.0] for example.

Rule2

The start address [xxx.xxx.xxx.0] and the last address [xxx.xxx.xxx.255] of the IP address must not be assigned to any other equipment. These address numbers are reserved.

Rule3

The IP address must correlate to a network number. If network numbers are different between the equipment, they cannot establish communications each other. In this case, the router is placed in the networks to make the routing.

Q *Can I control the projector by using the telnet application?*

A Possible. Please refer to the item "Use of telnet" (☞ p.48 - 49).

Q *What is the MAC address assigned to the projector?*

A The MAC address is displayed in "Network information" menu of the projector (☞ p.14) and in "Information" menu through the web browser (☞ p.42).

Q *Can I update the firmware of the projector.*

A It is possible to update the firmware through the network. It is required to have a special tool for the updating. For further information please consult your local dealer. The version number of the firmware is indicated on the lower part of the "Initial setting" page.

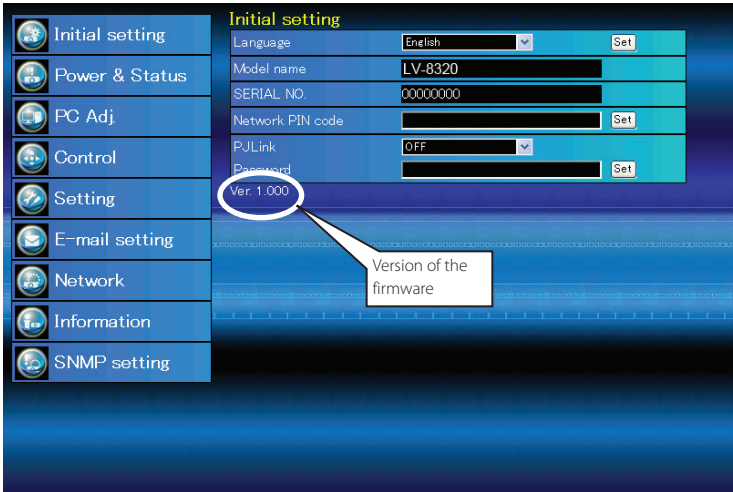

Menu Tree

Projector Menu



Network

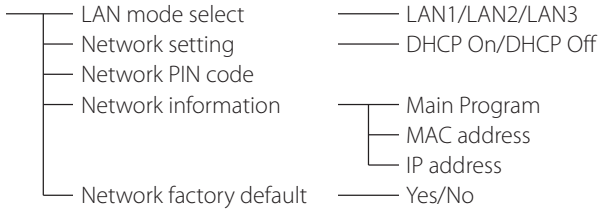

Web Menu



Initial setting

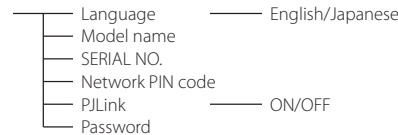

Power & Status



PC Adj.

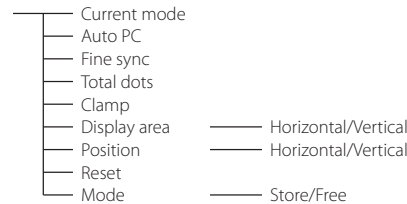

Control

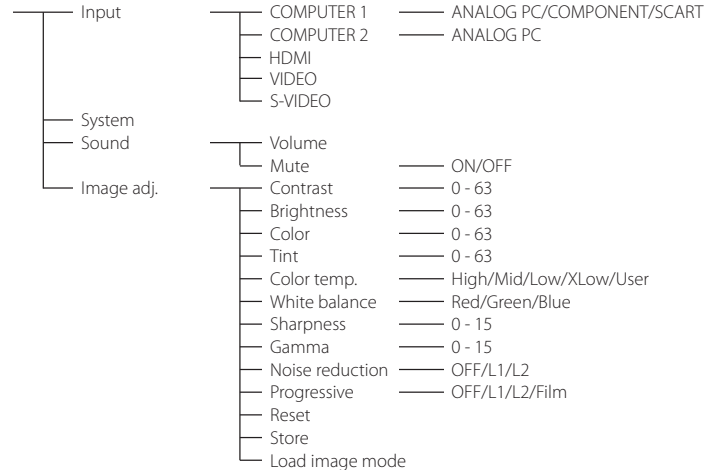

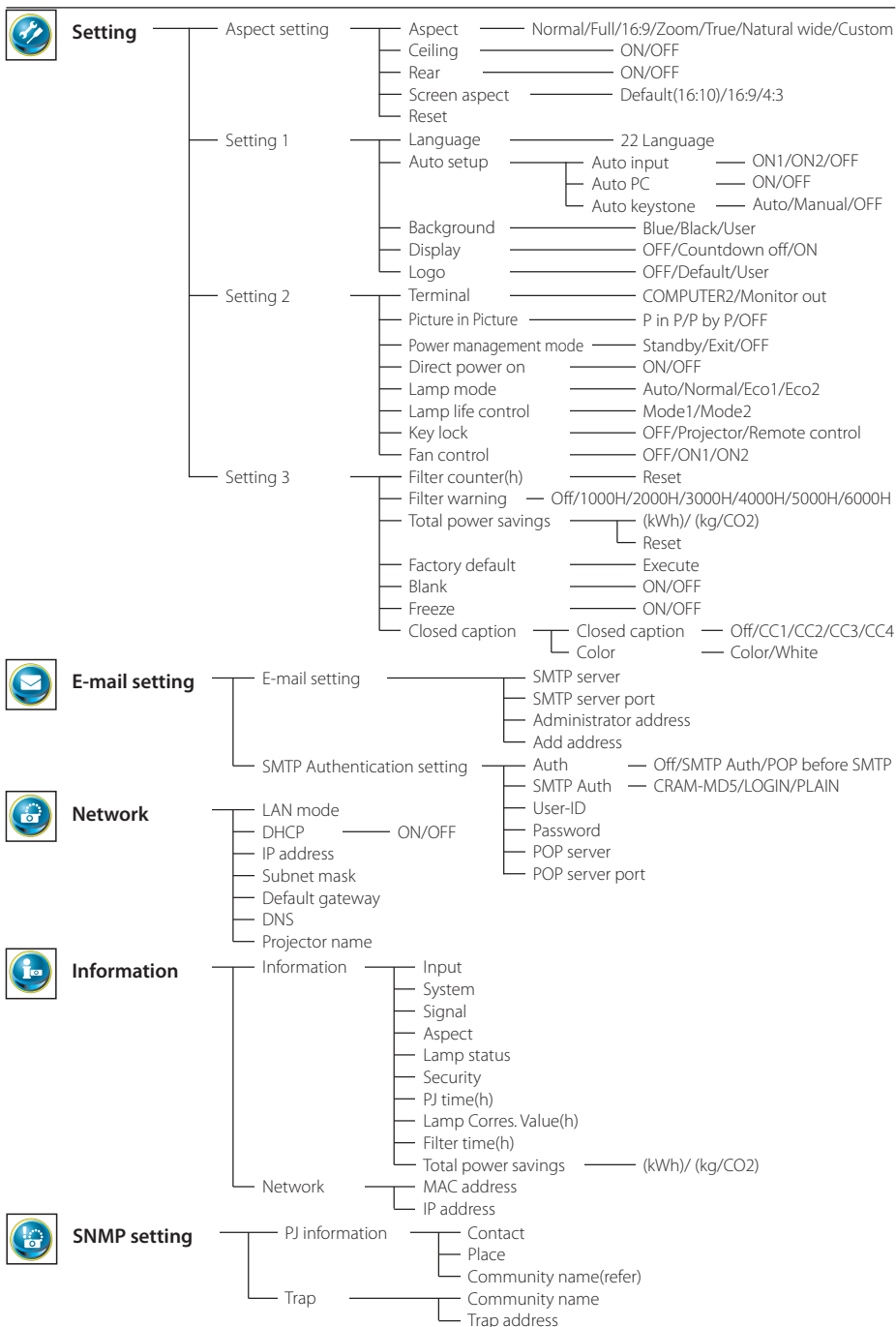

**CANON INC.**

30-2, Shimomaruko 3-chome, Ohta-ku,
Tokyo 146-8501, Japan

U.S.A.**CANON U.S.A. INC.**

One Canon Plaza, Lake Success, NY
11042-1198, U.S.A.

*For all inquiries concerning this product, call
toll free in the U.S. 1-800-OK-CANON*

CANADA**CANON CANADA INC. HEADQUARTERS**

6390 Dixie Road, Mississauga, Ontario L5T
1P7, Canada

CANON CANADA INC. MONTREAL BRANCH

5990, Cote-de-Liesse, Montreal Quebec H4T
1V7, Canada

CANON CANADA INC. CALGARY OFFICE

2828, 16th Street, N.E. Calgary, Alberta T2E
7K7, Canada

*For all inquiries concerning this product, call
toll free in Canada 1-800-OK-CANON*

EUROPE, AFRICA & MIDDLE EAST**CANON EUROPE LTD.**

3 The Square, Stockley Park, Uxbridge,
Middlesex, UB11 1ET United Kingdom

CANON EUROPA N.V.

Bovenkerkerweg 59-61, 1185 XB Amstelveen,
The Netherlands

CANON FRANCE S.A.S

17, quai du President Paul Doumer, 92414
Courbevoie Cedex, France

CANON UK LTD.

Woodhatch Reigate Surrey RH2 8BF,
United Kingdom

CANON DEUTSCHLAND GmbH

Europark Fichtenhain A10, 47807 Krefeld,
Germany

CANON ITALIA S.p.A.

Via Milano 8 I-20097 San Donato Milanese,
Milano, Italy

CANON Schweiz AG

Geschäftsbereich Wiederverkauf,
Industriestrasse 12, CH-8305 Dietlikon,
Switzerland

CANON GMBH

Zetschegasse 11, A-1230 Wien, Austria

CANON España, S.A.

C/Joaquin Costa, 41, 28002 Madrid, Spain

CANON PORTUGAL S.A.

Rua Alfredo da Silva, 14 Alfragide 2610-016
Amadora, Portugal

CANON Belgium N.V./S.A.

Berkenlaan 3, 1831 Diegem (Mechelen), Belgium

CANON Netherland NV

Neptunusstraat 1, 2132 JA Hoofddorp,
The Netherlands

CANON LUXEMBOURG S.A.

Rue des Joncs 21, L-1818 Howald, Luxembourg

CANON DANMARK A/S

Knud Høejaards Vej 1 DK-2860 Soeborg,
Danmark

CANON OY

Huopalahdentie 24 PL 1 00351 Helsinki, Finland

CANON SVENSKA AB

Gustav III:s Boulevard 26 169 88 Solna, Sweden

CANON NORGE as

Hallagerbakken 110, Postboks 33, Holmlia, 1201
Oslo, Norway

CENTRAL & SOUTH AMERICA**CANON LATIN AMERICA, INC.**

703 Waterford Way, Ste. 400 Miami, FL 33126,
U.S.A.

ASIA**CANON (China) Co., Ltd.**

15F Jinbao Building No.89 Jinbao Street,
Dongcheng District, Beijing 100005, China

CANON HONGKONG CO., LTD.

19/F., The Metropolis Tower, 10 Metropolis Drive,
Hung Hom, Kowloon, Hong Kong

CANON SINGAPORE PTE. LTD.

1 HarbourFront Avenue, #04-01 Keppel Bay
Tower, Singapore 098632

CANON KOREA CONSUMER IMAGING INC.

Gangnam Finance Center 17F, 737, Yeoksam-
Dong, Gangnam-gu, Seoul, 135-984, Korea

OCEANIA**CANON AUSTRALIA PTY. LTD.**

1 Thomas Holt Drive, North Ryde, N.S.W. 2113,
Australia

CANON NEW ZEALAND LTD.

Akoranga Business Park, Akoranga Drive,
Northcote, Auckland, New Zealand

LV-8320

NETWORK USER'S MANUAL

SO-KC2PC

© CANON INC. 2011